

HYDROline PRO - F900

ALUMINIUM

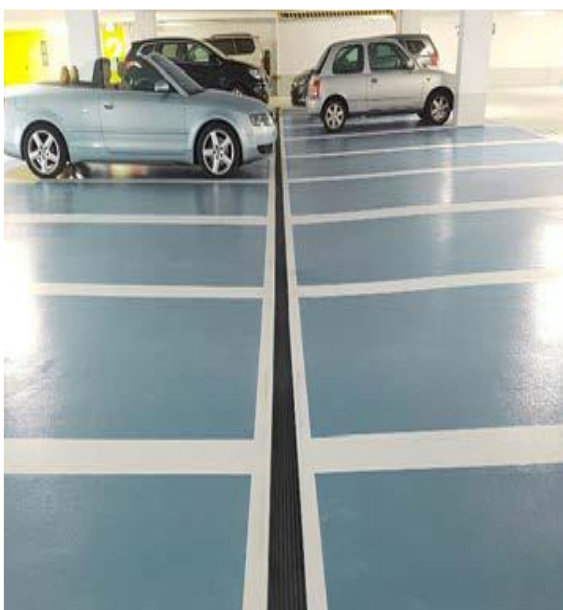

Garageanlæg



Parkeringshuse



Industriområder

HYDROline PRO

HYDROline PRO er fremstillet i aluminium, og har en byggehøjde på kun 30 mm. Dette gør HYDROline PRO til en ideel afvandingsløsning til eksempelvis parkeringshuse eller andre områder, hvor der er krav til afløbsrendens højde. HYDROline PRO kan derudover anvendes til belastninger op til 90 tons (F900).

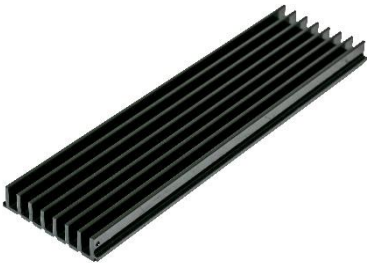

HYDROline PRO,
Længde: 1000 & 3000 mm



HYDROline PRO kan samles
i bredden

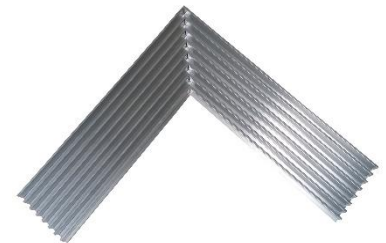

HYDROline PRO forskårede 45
graders hjørneelement, 500 mm

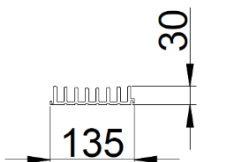

HYDROline PRO, 1000 mm

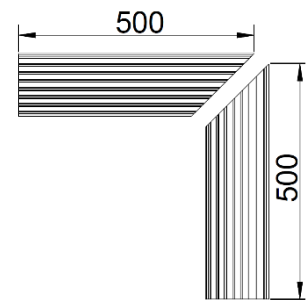
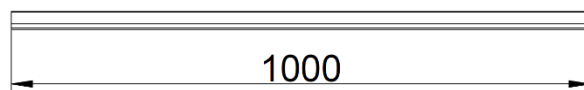

HYDROline PRO hjørneelement
500 x 500 mm

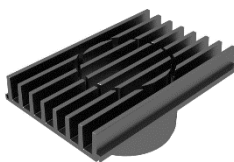

HYDROline PRO afløbselement, 200 mm

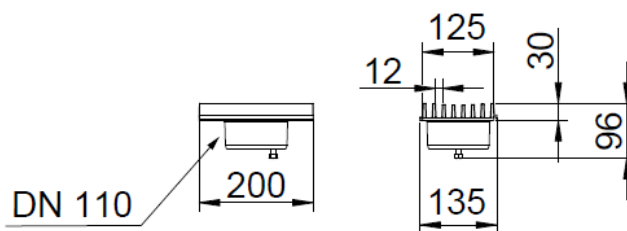

Varenummer:	DB-nummer:	Beskrivelse:	Materiale:	Belast.:	Vægt i kg:
690 0000	1990554	HYDROline PRO 1000 mm	Aluminium	A15 – F900	12,0
690 0010	1990556	HYDROline PRO 3000 mm	Aluminium	A15 – F900	4,5
690 0015	1990557	HYDROline PRO Hjørneelement 500 x 500 mm	Aluminium	A15 – F900	2,5
690 0020	1990558	HYDROline PRO m. Ø110 afløb 200 mm	Aluminium	A15 – F900	2,5
700 3700	1990559	HYDROline PRO Endevæg	Rustfrit stål	A15 – F900	-
700 3701	1990560	HYDROline PRO Forankringsplade	Rustfrit stål	A15 – F900	-
700 3702	1990562	HYDROline PRO Forbindelsesstykke	Rustfrit stål	A15 – F900	-
700 3704	1990561	HYDROline PRO Justerbar forankringsholder	Rustfrit stål	A15 – F900	-
700 3730	1990563	HYDROline PRO Renderenser	Rustfrit stål m. træskaft	A15 – F900	-